



AFRISO EUROGAUGE

Afriso Eurogauge Ltd
Unit 4, Satellite Business Village
Fleming Way, Crawley
West Sussex. UK
RH10 9NE
Tel: +44 (0) 1293 658363
Fax: +44 (0) 1293 528270
email: sales@eurogauge.co.uk
web: www.eurogauge.co.uk



Operating Instructions

Digital Display Devices DA 10 / 12 / 14

DA 10	PN 31281
DA 12	PN 31282
DA 14	PN 31283

- ☞ Read instructions before using device!
- ☞ Observe all safety information!
- ☞ Keep instructions for future use!

Version: 09.2003
Id.-no.: 854.000.0345GB

Contents

Contents	1 Application	3
	2 Product description	4
	3 Technical specifications	5
	4 Transportation / mounting	8
	5 Electrical connection	9
	6 Commissioning	12
	7 Programming	13
	7.1 Display and controls.....	13
	7.2 Checklist parameters.....	14
	7.3 Menu.....	16
	7.4 Input.....	18
	7.5 Scaling of display.....	20
	7.6 Filter.....	20
	7.7 Analogue output.....	21
	7.8 Limit values / relay.....	22
	7.9 Password.....	23
	7.10 Simulation parameters.....	24
	7.11 Characteristic / linearisation.....	25
	7.12 Factory defaults.....	27
	8 Operating modes	28
	8.1 Normal mode.....	28
	8.2 Simulation mode.....	30
	8.3 Programming mode.....	31
	9 Example: level measurement with DMU 08	32
	9.1 Application.....	32
	9.2 Electrical connection.....	33
	9.3 Programming.....	34
	10 Appendix	36
	10.1 Troubleshooting.....	36
	10.2 Replacement.....	36
	10.3 Spare parts and accessories.....	37
	10.4 Maintenance, repair.....	37
	10.5 Shutting down, disposal.....	37
	10.6 Warranty.....	38
	10.7 Liability information.....	38
	10.8 Copyright.....	39
	10.9 Customer satisfaction.....	39
	10.10 Addresses.....	40

1 Application

The DA 10/12/14 digital display devices may only be used for displaying, evaluating and controlling the appropriate input signals.

Any use other than the use explicitly permitted in this instruction manual is not permitted.

Unauthorised changes or modifications to the product incur significant safety risks and are prohibited for reasons of safety. AFRISO EUROGAUGE shall not be liable for damages resulting from such tampering or for damages resulting from any use other than the use explicitly permitted in this instruction manual.



Important!

The operation, maintenance and repair conditions must always be met.

Additional devices used to transmit the output signal may only be installed by trained electricians. The DA 10/12/14 digital display devices must not be operated in hazardous areas. Usage of the devices in hazardous areas, sparking may cause detonations, fire or explosions.

The digital display devices may only be used:

- for the applications described in this manual and,
- only if they are in perfect technical condition.

Malfunctions or problems which may interfere with the safety of the device must be repaired/fixed immediately!

Work on the electrical parts may only be performed by trained electricians in accordance with the applicable regulations and directives. Staff under training may only work with the product if supervised by an experienced person. The installing party must hand over this instruction manual to the operator.

Both the installing party as well as the operator must have read and fully understood this instruction manual prior to working with the product

The product must not be operated by persons less than 16 years of age.

2 Product description

2 Product description

The DA 10 / 12 / 14 digital display devices consist of a sturdy housing (IP 65 front side), designed for panel mounting. Screw/plug terminals at the rear side are used for electrical connection. A variable clamping unit at both sides of the device is used for mechanical fastening..



- ✓ 5-digit graphical LCD display
- ✓ Text-based user interface
- ✓ Linearisation for indication of volume
- ✓ Selectable unit
- ✓ Universal power supply unit 20...253 V AC/DC
- ✓ Integrated power supply for transducer
- ✓ Analogue outputs (see type overview)
- ✓ Relay outputs (see type overview)
- ✓ Simulation mode
- ✓ Password protection
- ✓ Min. / max. value memory
- ✓ Pluggable screw terminals
- ✓ Error alarm for sensor defect

Type overview

This instruction manual is designed to provide information on commissioning, setting up and operating the DA 10 / 12 / 14 digital display devices. The devices differ in terms of the available analogue and voltage-free outputs..

Product no. 31281 **DA 10** 1 analogue output current (20 mA))

Product no. 31282 **DA 12** 1 analogue output current (20 mA)
1 analogue output voltage (10 V)
2 relays (voltage-free, changeover)

Product no. 31283 **DA 14** 1 analogue output current (20 mA)
1 analogue output voltage (10 V)
4 relays (voltage-free, changeover)

3 Technical specifications

Housing	Type: panel housing according to DIN 43700 Front frame: 96 x 48 mm Dimensions: 91,5 x 43 x 131 mm (WxHxD) Cutout : 92 x 44 mm Panel thickness: 1,5...10 mm Fastening: 2 clamps at the sides Weight: approx. 320 g Terminals: 1.5 mm ² (2.5 mm ² for mains terminals)															
Ambient	Temperature: ambient -10...+70°C Storage: -40°C...+85°C (no condensation)															
Protection	Class : II Type : front IP65, terminals IP20															
Power supply	Universal: 20...253 V AC/DC max. 4 or 7,2 VA															
Input	<table border="0"> <tr> <td>Current</td> <td>20 mA</td> <td>(Ri approx. 120 Ohm)</td> </tr> <tr> <td rowspan="4">Voltage:</td> <td>+/- 10 V</td> <td>(Ri approx. 50 kOhm)</td> </tr> <tr> <td>+/- 5 V</td> <td>(Ri approx. 100 kOhm)</td> </tr> <tr> <td>+/- 1 V</td> <td>(Ri approx. 100 kOhm)</td> </tr> <tr> <td>+/- 100 mV</td> <td>(Ri approx. 100 kOhm)</td> </tr> <tr> <td>Scanning rate:</td> <td colspan="2">0,2 seconds</td> </tr> </table>	Current	20 mA	(Ri approx. 120 Ohm)	Voltage:	+/- 10 V	(Ri approx. 50 kOhm)	+/- 5 V	(Ri approx. 100 kOhm)	+/- 1 V	(Ri approx. 100 kOhm)	+/- 100 mV	(Ri approx. 100 kOhm)	Scanning rate:	0,2 seconds	
Current	20 mA	(Ri approx. 120 Ohm)														
Voltage:	+/- 10 V	(Ri approx. 50 kOhm)														
	+/- 5 V	(Ri approx. 100 kOhm)														
	+/- 1 V	(Ri approx. 100 kOhm)														
	+/- 100 mV	(Ri approx. 100 kOhm)														
Scanning rate:	0,2 seconds															
Transmitter supply	Voltage: 20 V at 20 mA (max. 30 V when idle) Current: max 4 mA during short circuit															
Analogue outputs (depending on type)	Current: 20 mA (max. 22 mA), configurable as required max. 500 Ohm Voltage: 10 V (max. 11 V), configurable as required min. 5 kOhm Error: linearity approx. 0.1 %															

3 Technical specifications

3 Technical specifications

Relay outputs (depending on type)	Type: voltage-free changeover Power: max. 100 W or 250 VA, respectively Inductive: use spark absorber (RC element) Voltage: max. 250 V AC/DC Current: max. 2 A AC / 1 A DC
Switching state indication (depending on type)	Indication visible: LCD display, letter at the left relay activated invisible: relay deactivated lowercase: relay was activated (memory mode)
Display	Graphical LCD: blue / white 122 x 32 pixels backlit Indication: 5 digits, configurable as required Unit: configurable Accuracy: +/- 0,5 % / +/- 1 digit
Guidelines for CE conformity	Emission: DIN EN 50081-2 Interference- voltage: DIN EN 55011 (industria) Immunity to- interference: DIN EN 55011 (industria) Immunity: DIN EN 50082-2 ESD: DIN EN 61000-4-2 Burst: DIN EN 61000-4-4 Surge: VDE 0843-5 HF: Current input DIN EN 61000-4-6 Fields: electromagnetic DIN EN 61000-4-3

3 Technical specifications

Dimensions

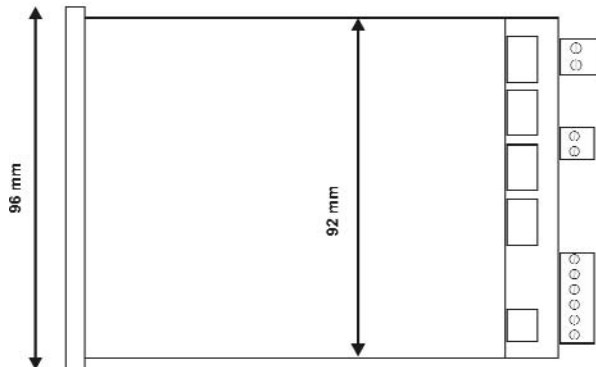
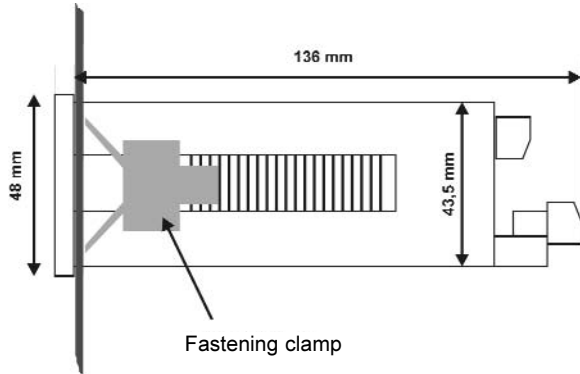

Contents of package

- Display device
- Fastening clamps (2 pieces)
- Front seal
- Terminals, depending on type
- Operating instructions

4 Transportation / mounting

4 Transportation / mounting

Transportation

The display devices are delivered together with this instruction manual in a box.

Do not throw or drop. The display devices may be damaged or scratched. Protect against wetness, humidity, dirt and dust.

Mounting

A panel cutout of 92 x 44 is required to mount the digital display device.

The clamp holders included with the device are suitable for a wall thickness of up to 10 mm. If several devices are mounted next to each other or on top of each other, the minimum horizontal distance between the devices is 20 mm, the minimum vertical distance between the devices is 10 mm. The installation depth is 136 mm.

Do not mount the devices in hazardous areas or next to noise or interference sources!

Mounting steps:

1. Create a panel cutout of 92 x 44 mm
2. Push the enclosed seal over the device from the rear end
3. Push the device through the panel cutout from the front
4. Push the holding clamps over the guide and let them snap in

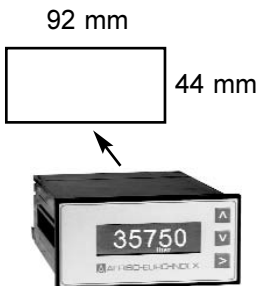

5 Electrical connection

Always switch off the voltage before performing connection work!!

Use a suitable surge protection device!

Supply
20...253 V AC/DC

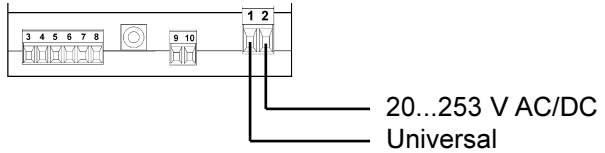

Transducer
4...20 mA / 2-wire

DMU03/08
(For example)

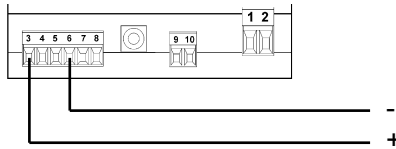

Transducer
0...20 mA / 3-wire

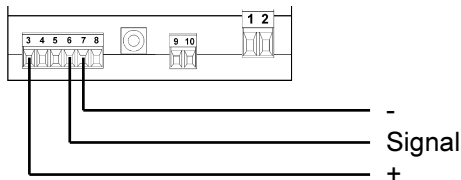

Transducer
0...10 V / 3-wire

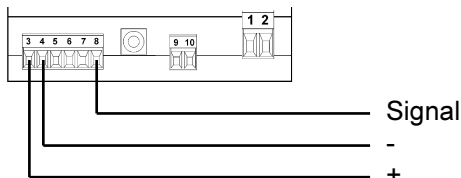

5 Electrical connection

5 Electrical connection

Always switch off the voltage before performing connection work!

Use a suitable surge protection device!

Current input
20 mA

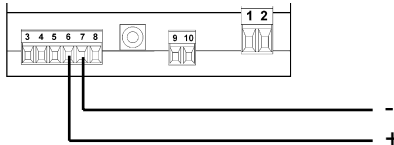

Voltage input
+/- 10V 5V 1V 100mV

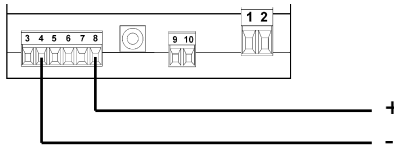

Current output
20 mA (max. 22 mA)

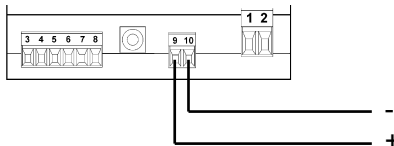

Voltage output
10 V (max. 11 V)

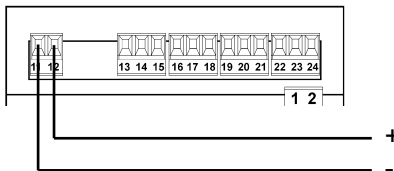

5 Electrical connection

Max. contact load.: AC 250 VA / 250 V / 2 A
DC 100 W / 250 V / 1 A

Use an external spark arrester in case of inductive loads!

Relay output A

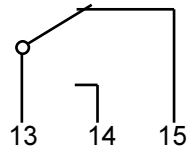
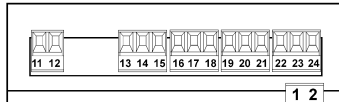

Relay output B

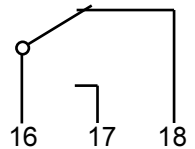
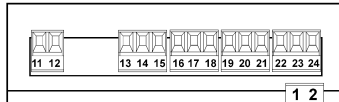

Relay output C

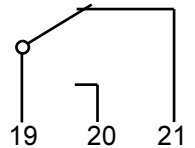
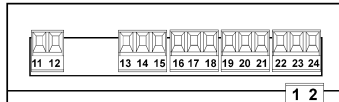

Relay output D

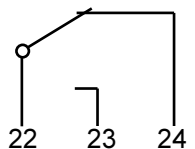
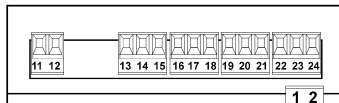

6 Commissioning

6 Commissioning

Check the appropriate boxes in the check list before commissioning the device:

Fill in check list



	OK	Not OK
● Mechanical installation	<input type="checkbox"/>	<input type="checkbox"/>
● Supply connection	<input type="checkbox"/>	<input type="checkbox"/>
● Input signal connection	<input type="checkbox"/>	<input type="checkbox"/>
● Connection outputs deactivated	<input type="checkbox"/>	<input type="checkbox"/>
● Connection relays deactivated	<input type="checkbox"/>	<input type="checkbox"/>

Disconnect the relay outputs
DA 12 / 14 only

The analogue output signals and the relay outputs must be disconnected prior to the first commissioning in order to avoid inadvertent switching of connected devices (pumps, valves, etc.). They are not connected until successful programming and simulation!

Switch on voltage

If all five points are OK, the digital display device is ready for operation. Switch on the voltage via your mains fuse or a switch.

The display shows the following device information for 3 seconds:



After that, the display switches to normal mod.

Troubleshooting

Problem	Solution
No display	Check supply voltage! Check fuse! Cable short circuit?
Display shows "sensor error"	Check transducer! Sensor cable interrupted?
Display shows "ADC overflow"	Sensor cable short circuit

7 Programming
7.1 Display and controls

The device is operated via the three keys on the front side. The graphical display indicates the measured values and the parameters in the form of text messages.



Functions:

"Up" key



Move up in a menu to select an item
Change a numeric value

"Down" key



Move down in a menu to select an item
Change a numeric value

"Set" key



If you hold down this key for more than three seconds, the system switches from display mode to programming mode and also returns to display mode from anywhere in the menu tree.
Confirm numeric values
Select a list item

7 Programming

7.2 Checklist parameters

7.2 Checklist parameters

This checklist is designed to facilitate programming of the device.

Simply enter the value required for your application in the "Application" column. The "Factory default" column shows the factory settings for the corresponding parameters.



	Factory default	Application
Input	Measuring range	4-20 mA
	Minimum	4 mA
	Maximum	20 mA
	(or teach current measured values)	
Scaling	Unit	litres
	Decimal point position	XXXXX,
	Minimum	00000
	Maximum	10000
Filter	Value	000
Current output	Minimum	4 mA
	Maximum	20 mA
Voltage output (DA 12 / 14 only)	Minimum	0 V
	Maximum	10 V

7.2 Checklist parameters

	Factory default	Application 
Relay A (DA 12/14 only)	Function	working
	Upper switching point	008000
	Lower switching point	007900
	Save	no
	Delay	000
Relay B (DA 12 / 14 only)	Function	working
	Upper switching point	008500
	Lower switching point	008400
	Save	nein
	Delay	000
Relay C (DA 14 only)	Function	working
	Upper switching point	009000
	Lower switching point	008900
	Save	nein
	Delay	000
Relay D (DA 14 only)	Function	working
	Upper switching point	009500
	Lower switching point	009400
	Save	nein
	Delay	000
Password	Activate	no
	Old password	00000
	New password	00000
Simulation	Minimum value	00000
	Maximum value	10000
	Delta	00010
	Timestep (s)	001
	Mode	off
Characteristic	Function	off

7 Programming

7.3 Menu

7.3 Menu

Analogue values

Hold down the Enter key for more than 3 seconds in order to switch from display mode to programming mode. After you have activated the programming mode, you can navigate by briefly pressing the appropriate keys.

A	265,34 litres
B	
C	
D	

```
--parameter--
> analog
limits
functions
```

```
--analog 1/2---
> input
scaling
filter
```

```
--analog 2/2---
> output 1
output 2
continue -
```

```
--input-----
input      4-20mA
manually
learn
```

```
--input manually-----
> min./mA  004,00
max./mA  020,00
continue
```

```
--input learn-----
> min./mA  004,00
max./mA  020,00
continue
```

```
--scaling 1/2-----
> unit      Liter
pointpos.  xxxxx,
```

```
--scaling 2/2-----
> minimum  00000
maximum   10000
continue
```

```
--filter-----
> value    000
continue
```

```
--output 1-----
> minimum  04,00
maximum   20,00
continue
```

```
--output 2-----
> minimum  00,00
maximum   10,00
continue
```

Navigation:

 up



 right
 pressing the key for
 > 3 seconds
 returns you to normal
 mode

 down

7.3 Menu

Limit values and functions

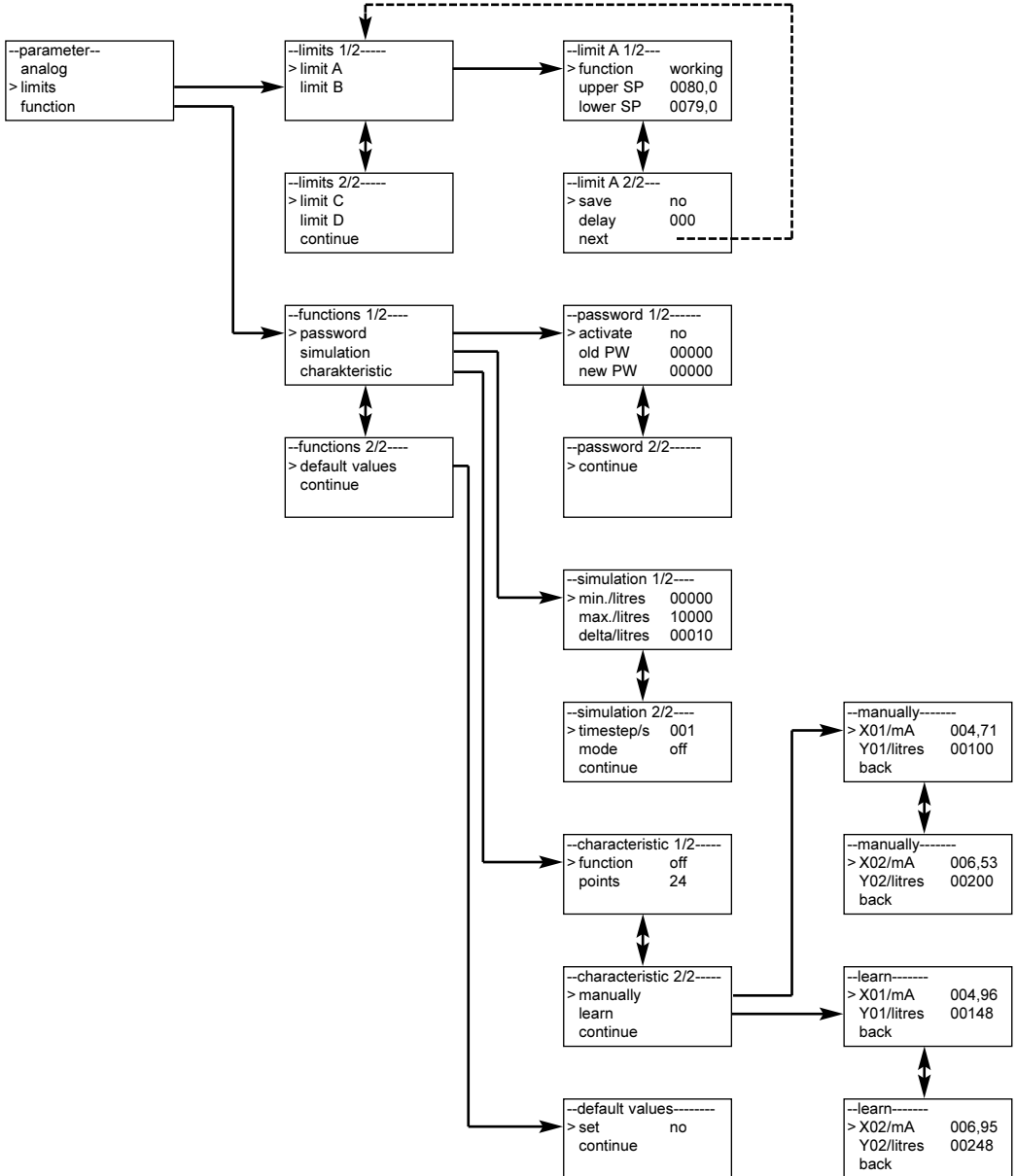



7 Programming

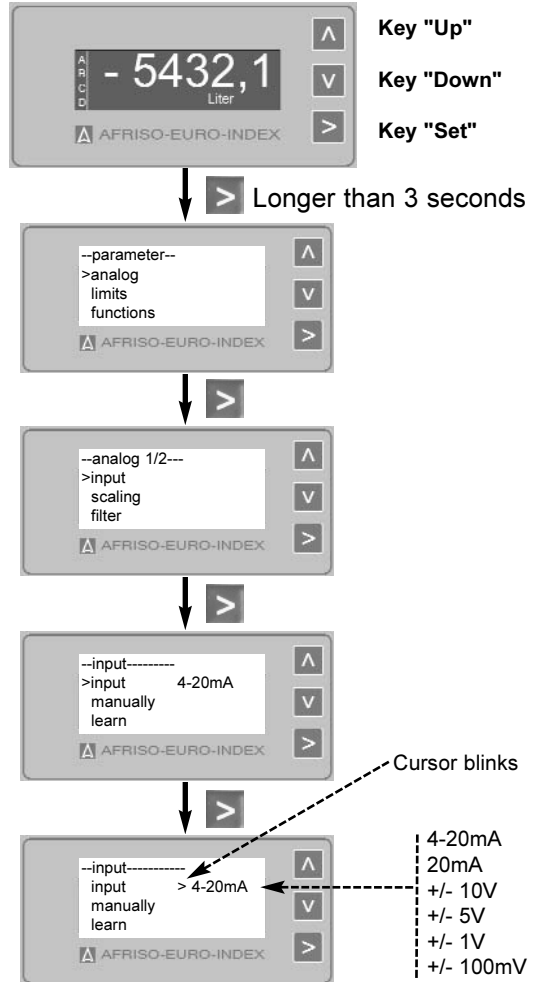

7.4 Input

7.4 Input



Select input signal

This menu item lets you select the input signal with the Up  and Down  keys.

Confirm your selection with the Set  key.
 Hold down the Set  key for more than 3 seconds to exit the menu.

7.4 Input

The functions "Input manually" and "Teach input" allow you to precisely adapt the input signal to the measuring task at hand.

Input manually

This menu lets you specify the minimum and maximum value of the measuring range in the form of numeric values.

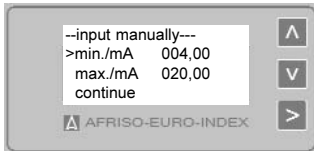

The unit and the adjustable range are determined by the preselected input signal (4-20 mA, 10 V, ...). If the device is to evaluate an input signal between 3.5 and 12.8 mA, the minimum value is 003.50 and the maximum value 012.80.

Teach input

This menu allows you to set the current sensor value as the minimum or maximum value of the range.

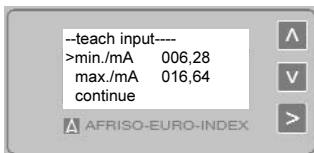

This function is particularly useful for level measurement. Simply press the Set key when the tank is full or empty to accept the current sensor signal as the maximum or minimum range value.

7 Programming

7.5 Scaling of display

7.6 Filter

7.5 Scaling of display

This menu allows you to assign a physical unit and a range to be displayed to the measured input (e.g. input signal 4...20 mA corresponds to the indication of 000.00...500.00 litres).



Unit

This menu item lets you select the desired unit from a list (litres, cbm, %, mWC, mm, cm, m, mbar, bar, psi, "WC, MPa, °C, mV, V, mA, l/s, l/min, cbm/h).

Decimal point position

Lets you specify the desired decimal point position.

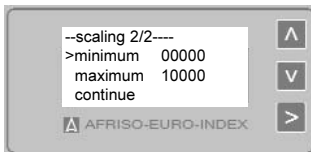

Minimum scale value

This menu item lets you specify the value the device is to display when the minimum input signal is available, e.g. 000.00 at 4 mA.

Maximum scale value

This menu item lets you specify the value the device is to display when the maximum input signal is available, e.g. 500.00 at 20 mA.

7.6 Filter

In order to dampen changing input signal values, you can add a filter. The possible filter values are 000 to 255.

Since the effect of the filter depends to a large degree on the type of the input signal and the selected measuring range, it is impossible to specify a time function that is always applicable. Usually, you will have to find the optimum filter value based on the experience made with the measurements.



General recommendation: time = filter value x 0.5 seconds

7.7 Analogue output

This menu allows you to set the minimum and maximum output values in mA and V.

The minimum value may be greater than the maximum value and vice versa.

For example, the minimum value may be 20 mA and the maximum value 4 mA so that you can create an inverted function.

Output 1:

Current output in the range from 0...20 mA / 20...0 mA.

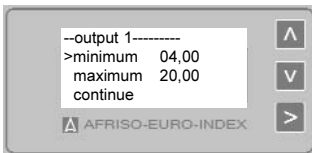

Output 2:

Voltage output in the range from 0...10 V / 10...0 V.

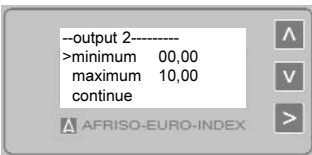

Example of inverted function:

Sensor input	Indication	Output
4 mA	0 litres	20 mA
12 mA	2500 litres	12 mA
20 mA	5000 litres	4 mA

7 Programming

7.8 Limit values relays

7.8 Limit values relays (DA 12 / 14 only)

This menu allows you to set all the required limit value parameters after the selection of the desired limit value (relay).

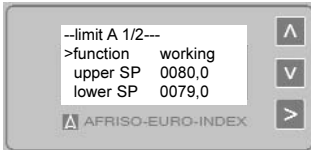

Function

“Off” Limit value processing off

“Working” Relay functions according to the open-circuit principle (the relay is **activated** when the limit value is exceeded)

“Rest” Relay functions according to the closed-circuit principle (relay is **deactivated** when the limit value is exceeded)

high

The relay function is activated when the high switching point set with this menu item is exceeded.

low

The relay function is activated when the value falls below the low switching point set with this menu item.



save

no The switching function is not saved.

yes The switching function is saved.

A lowercase letter in the display indicates that the corresponding relay has switched in the meantime.

Delay

The relay is activated or deactivated after the delay time specified. The delay time can be any value from 0 to 255 seconds.

next

The system jumps to the selection of the next relay.

7.9 Password

This menu allows you to change the password and to activate or deactivate password protection.

Activate

no Password protection is off.

yes Password protection is activated after a period of at least 3 minutes. Prerequisite: no key was pressed during this 3 minutes phase and the power supply was not interrupted.

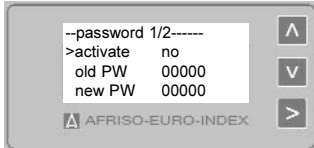

Access with activate password protection

If the password protection is on, set parameters can be displayed, but not changed. The device activates the "old password" screen and prompts the user for a valid password. If you have entered the correct password and confirmed it with the Set key, programming is released for a period of 3 minutes after the last time you pressed a key. If you do not press any key for a period of 3 minutes, the device automatically returns to display mode and activates the password protection.

Changing the password

In order to change the factory default password (00000), the same value must be entered for "old password" and "new password". The value entered is the new password.

Attention: Make a note of the new password!!

If you have forgotten the modified password, you can request a valid password from the manufacturer if you specify the value shown in the field "old password".

Continue

The device returns to display mode.



7 Programming

7.10 Simulation parameters

7.10 Simulation-parameters

This menu lets you set the simulation parameters and start or end the simulation mode.

The "Simulation" mode is described in detail on page 30.



Minimum

Enter the minimum value of the simulation in the scale unit.

Maximum

Enter the maximum value of the simulation in the scale unit.

Delta

Enter the increments for the simulation in the scale unit. In simulation mode, the device increases or decreases the simulated value in the increment specified.

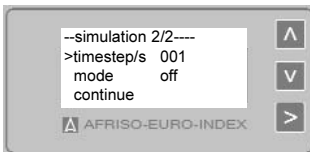

Time step

This parameter lets you specify a period from 000...255 seconds. The simulated value is increased or decreased at the intervals specified.

Mode (see page 30)

- Off The simulation mode is off.
- Temporary Switches the simulation mode on for a period of 3 minutes. The "Up" and "Down" keys let you increase or decrease the value.
- Permanent Sets the device to permanent simulation mode. To return to normal mode, you must select mode "off".

Continue

The system returns to display mode.

7.11 Characteristic / linearisation

This menu allows you to specify up to 24 point to linearise the measured value. It is also possible to choose one of two fixed characteristics (horizontal cylindrical tank or ball-shaped tank). The points specified are not overwritten by the factory defaults.

Function

Off	Switches off the characteristic mode.
Table	Activates the user-defined table.
Horiz. cyl.	Activates the table for the horizontal cylindrical tank.
Ball	Activates the table for a ball-shaped tank.

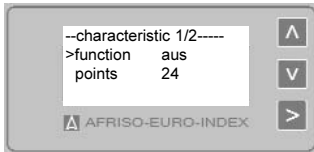

In the case of the selection of "Table"

If you choose a user-defined table via the Function menu, the following values must be specified.

Points

Allows you to specify the number of points for the user-defined table. You may select from 3 to 24 points.

Die Werte für die einzelnen Punkte können anschließend manuell eingegeben oder gelernt werden.

Manually

Xn

x value of the current point in mA.

Yn

y value of the current point in the scale unit.

All further points X 02 to X 24 are activated via the "manually" menu by means of the "Down" key.

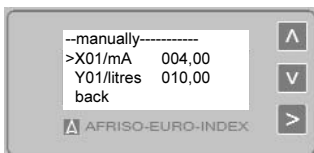
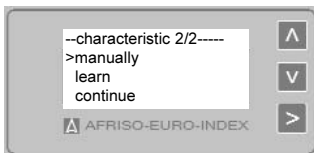

7 Programming

7.11 Characteristic / linearisation

7.11 Characteristic / linearisation

"Teaching" the characteristic

If you want to measure the volume of a tank that does not correspond to a given characteristic, you may teach in the individual points.

To do so, fill the tank step by step and teach in the individual points.

Example:

A tank with a total volume of 5000.0 litres is measured with a level sensor (4...20mA). When scaling the display (chapter 7.5, page 20), set the minimum scale value to 004.00 mA / 0000.0 litres and the maximum scale value to 020.00 mA / 5000.0 litres.

Now fill 200 litres, for example, to get to the first point. Press the Enter key so that the cursor jumps to the first input signal X01/mA > **4.79**. This measured value is accepted with the Enter key. Then move to the scale value Y01/litres **200.00** with the Down and the Enter keys. Enter the number of litres in the tank and confirm with Enter. Now press the Down key to jump to the next point.

Continue to fill the tank until you have reached the level for the next point and teach in the appropriate values as described above.

Repeat this process until you have specified all point.

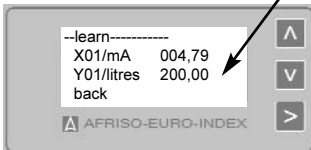
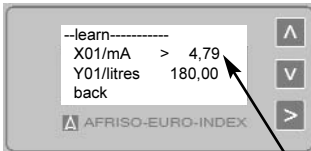

7.12 Factory defaults / default values

This menu lets you default values to the factory defaults to obtain a defined basic state.

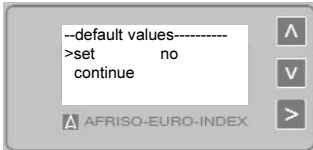

set

no Do not reset to factory defaults.

Yes When you exit the menu, the settings are overwritten by the factory defaults, i.e. the device performs a reset and returns to normal mode.

Factory defaults:

Input	4-20 mA
Unit	litres
Decimal position	XXXXX,
Minimum scale value	00000
Maximum scale value	10000
Filter	000
Analogue output 1	4...20 mA
Analogue output 2	0...10 V
Limit values	
Function	working
High switching point	A 08000 / B 08500 / C 09000 / D 09500
Low switching point	A 07900 / B 08400 / C 08900 / D 09400
Delay	000
Password*	00000*
Simulation	
Minimum	00000 litres
Maximum	10000 litres
Delta	00010 litres
Time step	001 second
Mode	off
Characteristic	
Function	off
Points	24

* If you have specified a password, it is not reset!

8 Operating modes

8.1 Normal mode

8 Operating modes

The device is always in one of the three following operating modes:

- Normal mode**
- Simulation mode**
- Programming mode**

8.1 Normal mode

When the device is switched on, it operates in normal mode (indication of measured values). In this mode, the device performs all the functions according to the set parameters. The Up and Down keys allow you to switch to different screens.

In this mode, you can also set the user interface to another language.

Standard indication

- Scaled measured value with 5 digits
- Physical unit
- Relay bar for relays A to D (depending on type)

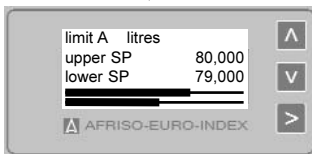

Limit values (depending on type)

- Limit value (relay) number
- physical unit
- upper switching point
- lower switching point
- Bar chart of the switching points

Version

- Type and version number
- Date and time since last compilation
- Manufacturer
- Serial number

continue on page 29

8.1 Normal mode

cont. from page 28

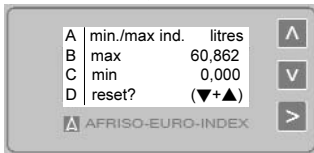

Min/max indicator (minimum/maximum value memory)

Unit

Max value

Min value

Reset (press Up and Down keys simultaneously)

Bar chart relays A - D

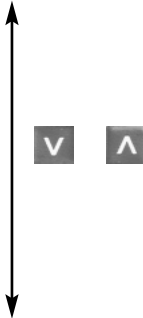

The min/max value function is activated when the device is switched on. To clear the minimum and maximum value, press the Up and Down keys simultaneously. Both the minimum and the maximum values are then set to the currently measured value.

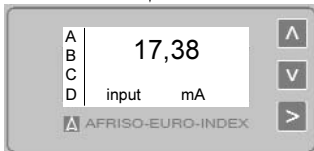

Current input signal

This screen displays the currently available input signal (not scaled and not filtered).

8 Operating modes

8.2 Simulation mode

8.2.1 Simulation mode

The simulation mode can be activated and deactivated via the menu.

In simulation mode, measurement is switched off and the measured value is simulated on the basis of the selected simulation parameters (chapter 7.10, page 24).

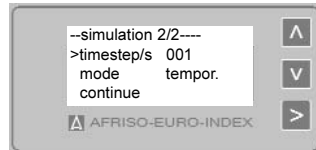

Temporary simulation mode

If the simulation mode is set to temporary, the simulation is deactivated when three minutes have passed and no key was pressed.

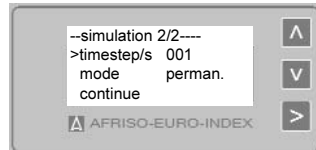

Permanent simulation mode

The simulation mode remains active without a time limit until is switched off via mode "off".

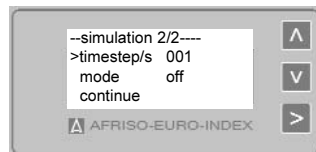

Mode off

This item lets you switch off the simulation mode.

Pressing the key for less than 3 seconds



- Value is increased by the set delta (1 increment)
- Stops and endless loop

Pressing the key for less than 3 seconds



- Value is decreased by the set delta (1 increment)
- Stops and endless loop

Pressing the key for more than 3 seconds



- Value is automatically increased by the set delta and according to the set time step (endless loop)
- Changes the direction of the endless loop

Pressing the key for more than 3 seconds



- Value is automatically decreased by the set delta and according to the set time step (endless loop)
- Changes the direction of the endless loop

8.3 Programming mode

To get from normal mode to programming mode, hold down the "Set" key for more than 3 seconds. The device functions continue to run in programming mode as in normal mode.

Changed parameter value become immediately effective. It is sufficient to hold down the "Set" key for more than 3 seconds to return from programming mode to normal mode if you do not want to go through the entire menu structure.

Saving parameter values

Changed parameter values are saved under the following conditions:

Numerical entries:

If you exit the menu with the navigation keys and if the value is not out of range.

If you exit a menu by holding down the "Set" key for more than three seconds, you return to normal mode. Changes are cancelled.

List items:

The values are saved if you confirm with the "Set" key.

If you hold down the "Set" key for more than three seconds, you return to normal mode. Changes are cancelled.

Language
German / English

Hold down all three keys for more than three seconds to toggle the user interface language (German/English).

Toggleing the language is only possible in normal mode.



9 Example: level measurement with DMU08

9.1 Application

9.1 Application

The level is to be measured in a horizontal, cylindrical tank in the range from 0 to 5000 litres. An alarm lamp with horn "low" is to indicate a low alarm level of less than 200 litres and a second alarm lamp "high" a high alarm level of more than 4900 litres. In addition, the tank level is to be transmitted to a central station by means of a 4...20 mA signal.

The complete measuring system

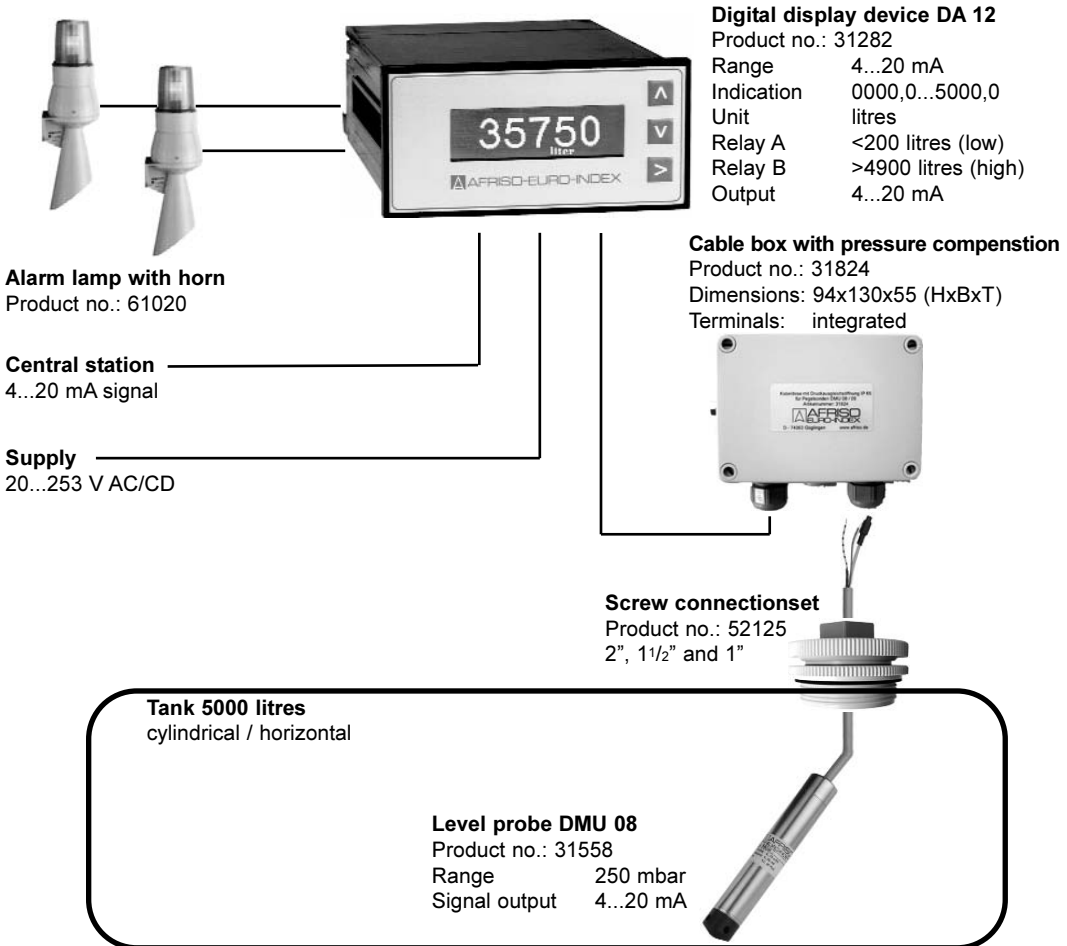

9 Example: level measurement with DMU08

9.2 Electrical connection

9.2 Electrical connection

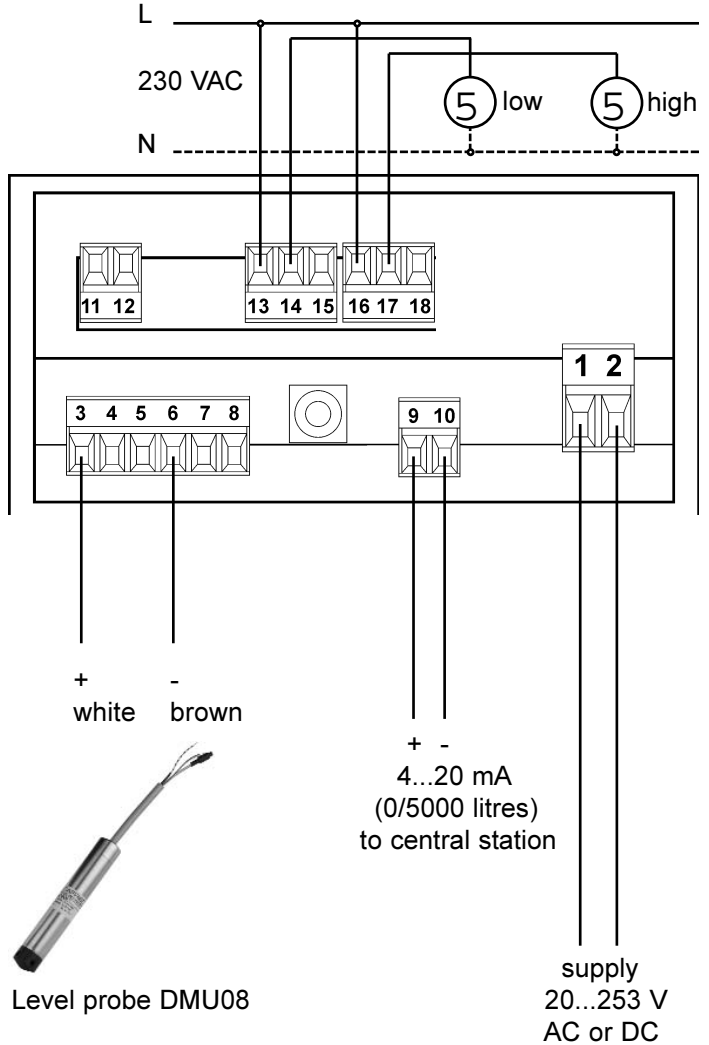

9 Example level measurement with DMU08

9.3 Programming

9.3 Programming

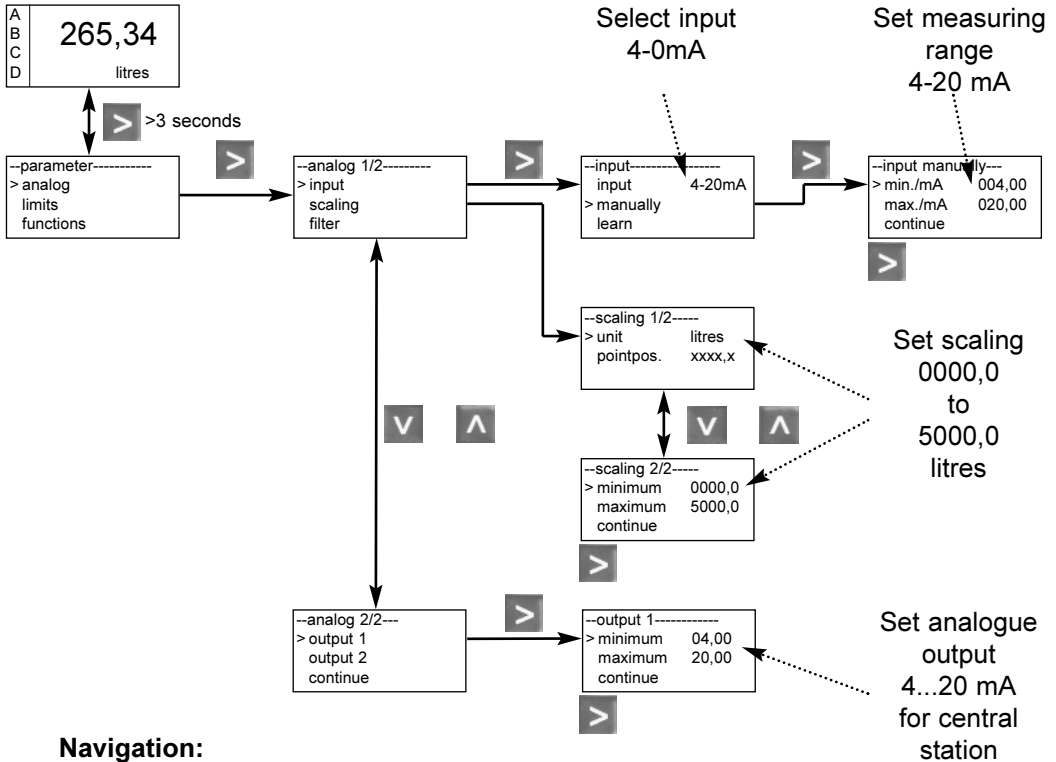

9.3 Programming

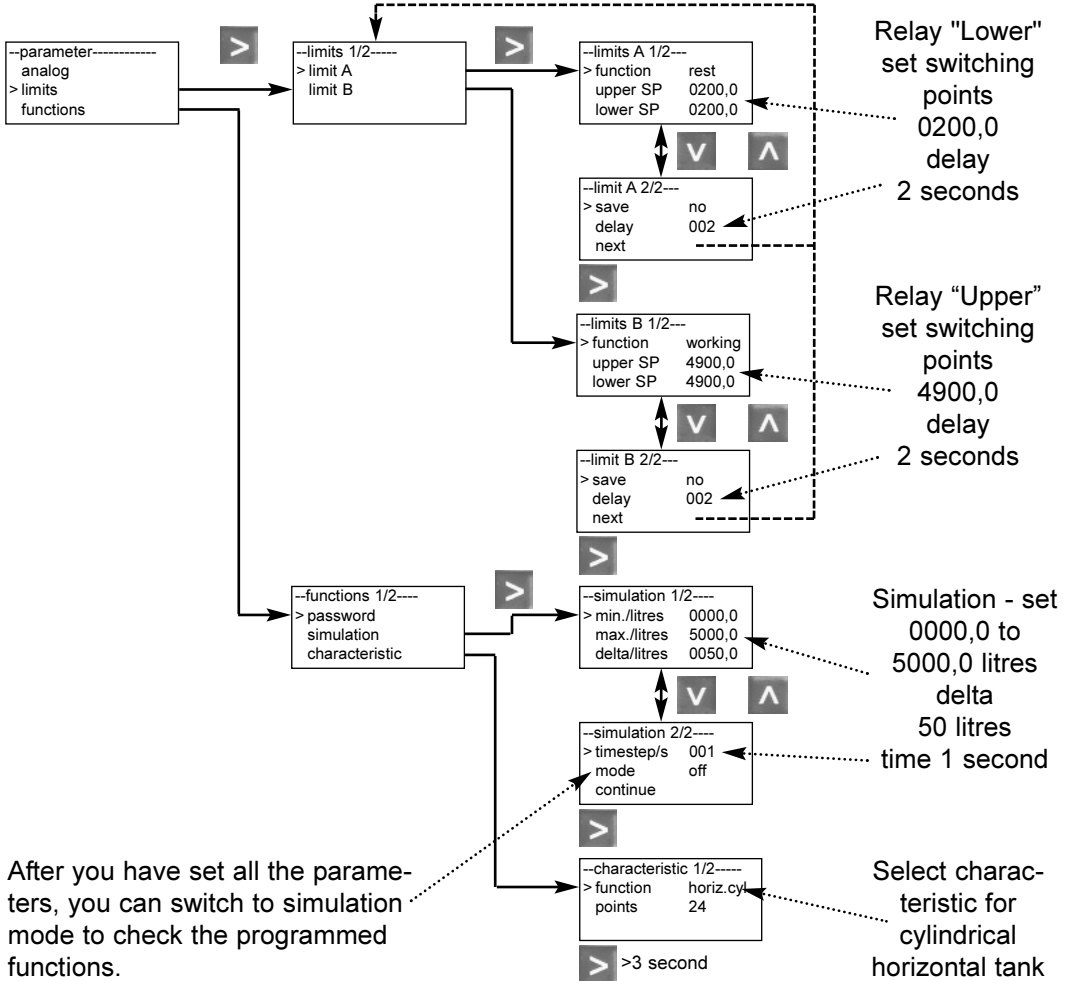

After you have set all the parameters, you can switch to simulation mode to check the programmed functions.

The simulation is started when you press or hold down the Up and Down keys

10 Appendix

10.1 Troubleshooting

10.2 Replacement

10 Appendix

10.1 Troubleshooting

Problem	Solution
No display	Check supply voltage! Check fuse! Cable short circuit?
Display shows "sensor error"	Check transducer! Sensor cable interrupted?
Display shows "ADC overflow"	Sensor cable short circuit

Electronic devices may only be repaired by the manufacturer.

10.2 Replacement

- Switch off the voltage supply
- Make sure the device is no longer connected to voltage
- Unplug the terminals
- Dismount the device
- Mount the replacement device
- Connect the system to power and to the sensor
- Switch on the voltage
- Program the device
- Check the functions by means of a simulation
- Switch off the voltage
- Plug in the outputs
- Switch on the voltage

10.3 Spare parts and accessories

Spare parts Terminals
 Rubber seal
 Holding clamps

Accessories

Housing for 1 DA	WAG 01	Product no. 31287
Housing for 2 DA	WAG 02	Product no. 31288
Housing for 3 DA	WAG 03	Product no. 31289
Housing for 4 DA	WAG 04	Product no. 31290

Dimensions WAG 02

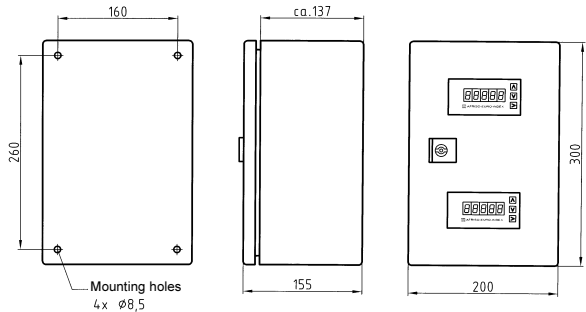

10.4 Maintenance and repair

If operated according to these instructions, DA 10/12/14 devices are maintenance-free. In the case of damages, the devices may only be repaired by the manufacturer.

10.5 Shutting down, disposal

To shut down a DA 10/12/14 device, disconnect the voltage and uninstall the device.
 For disposal, remove the housing parts from the board and dispose of them according to your national/local regulations (recycling companies, etc.).

10.6 Warranty

The manufacturer's warranty for this product is 24 months after the date of purchase.

Within the warranty period, we shall repair or replace, at our discretion, free of charge, all defects of the device resulting from defective materials or workmanship.

The following defects are not covered by the warranty: defects resulting from the improper use of the device, from normal wear and tear, and defects which affect the value or usability of the device only to a minor degree.

The warranty shall be void if spare parts other than genuine AFRISO spare parts are used or if unauthorised parties open the product, modify it or tamper with it in any other unauthorised way. This warranty shall be good in all countries in which this device is sold by AFRISO-EURO-INDEX or its authorised dealers.

10.7 Liability Information

The manufacturer or the sales company shall not be liable for costs or damages incurred by the user or by third parties in the usage or application of this device, in particular in the case of improper use of the device, misuse or malfunction of the connection, malfunction of the device or other devices.

Avoid extreme ambient conditions, in particular humidity and heat.

Unauthorised modifications of the device are prohibited! The warranty shall be void in case of such modifications.

Neither the manufacturer nor the sales company shall be liable if the device is not used as per instructions.

10.8 Copyright

© AFRISO-EURO-INDEX GmbH. This manual may only be reprinted, translated, copied in part or in whole with the prior written consent by Afriso-Euro-Index GmbH. We reserve the right to technical modifications with reference to the specifications and illustrations in this manual.

10.9 Customer satisfaction

Customer satisfaction is our prime objective. Please get in touch with us if you have questions, suggestions or problems with your AFRISO product.

email address: sales@eurogauge.co.uk

10 Appendix

10.10 Addresses

10.10 Addresses

Afriso Eurogauge Ltd
Unit 4, The Satellite Business Village
Fleming Way, Crawley
West Sussex. UK
RH10 9NE

Tel: +44 (0) 1293 658363

Fax: +44 (0) 1293 528270

email: sales@eurogauge.co.uk



Worldwide representation can be found at

www.eurogauge.co.uk



AFRISO
product catalogue:

Pressure - Temperature - Level

