



Singelgatan 2
 212 28 Malmö
 Sweden
 tel +46 40 922050
 fax +46 40 193358

Afriso Eurogauge Ltd
 Unit 4, Satellite Business Village
 Fleming Way, Crawley, RH10 9NE
 Tel: +44(0)1293 658360
 Fax: +44(0)1293 528270
 sales@eurogauge.co.uk
 www.eurogauge.co.uk



Installation Manual

**Oil-petrol-grease alarm
 Type ema signal OSA**



**Level Alarm Unit type OSA
 Capacitance Oil Alarm Probe type ES4
 Thermistor High Level Alarm Probe type R6**

- * Read this manual fully before installing the equipment !
- * Observe all relevant safety regulations !
- * Save the Installation Manual for future reference !

CONTENTS

1	DECLARATION OF CONFORMITY	3
1.1	Declaration of conformity for alarm unit ema Signal type OSA	3
1.2	Declaration of conformity probes type ES4 and R6	3
2	DESCRIPTION	4
2.1	Contents	4
2.2	Application (description)	4
2.3	Function	4
2.4	Front panel pushbuttons and LED indicators	4
2.5	Technical specifications	5
2.5.1	ema Signal type OSA Alarm Unit	5
2.5.2	Probes type ES4 and R6	5
3	INSTALLATION ema signal OSA	6
3.1	General information	6
3.2	Mounting	6
3.3	Connections	6
3.4	Checking	7
3.5	Start Up	7
3.6	Operating information	7
3.7	Warning!	7
3.8	Repair and modifications	7
4	INSTALLATION SENSOR ES4 AND R6.....	8
4.1	General information	8
4.2	Mounting	8
4.3	Checking	8
4.4	Connection for surface alarm only	9
4.5	Connection for both surface and high level alarm.....	10
5	USER INSTRUCTIONS	11
5.1	Front buttons and led indicators	11
5.2	Start up of the unit	11
5.3	Operating informations	11
5	CERTIFICATE	12
5.1	Certificate ema signal OSA	12
5.2	Certificate givare ES4	13
5.3	Certificate givare R6	14

1 DECLARATION OF CONFORMITY

1.1 Declaration for the electronic unit ema Signal type OSA



Declaration of conformity

ema Signal OSA 230 V, 50 Hz

This is to certify that the above named product fully complies with the requirements of the normative sections of the following harmonised European Standards.

Emission according to EN 50081-1

Immunity according to EN 50082-2

Signed: 

Urban Nilsson

Befattning: Technical Manager

Datum: 2004-06-04

1.2 Declaration capacitance probe ES4 and thermistor probe R6



Declaration of conformity

Capacitance probe type ES4

Thermistor probe type R6

This is to certify that the above named product fully complies with the requirements of the normative sections of the following harmonised European Standards.

Emission according to EN 50081-1

Immunity according to EN 50082-2

Signed: 

Urban Nilsson

Befattning: Technical Manager

Datum: 2004-06-04

2 DESCRIPTION

2.1 System parts

Electronic unit type ema signal type OSA for connection to capacitance probe ES4 and thermistor probe R6.

2.2 Application (description)

The ema Signal type OSA Alarm Unit is intended for wall mounting and designed for use with capacitance probe type ES4 to provide an oil level alarm in oil and grease separators. The OSA Alarm Unit can also be connected to a thermistor probe type R6 to provide a high level liquid alarm in the event of a blockage in the outlet of the separator.

2.3 Function

The sensing probe circuits are intrinsically safe.

The OSA has a selectable jumper link on the printed circuit board (only accessible with the front cover removed) which provides selection for the number of sensing probes. It has two positions, 1 = capacitance probe type ES4 only, 2 = ES4 probe and thermistor sensing probe type R6.

On start-up the OSA automatically checks to determine if one or two sensors are connected. With the jumper link in position 1 the unit will not give a sensor fault alarm when the thermistor probe type R6 is omitted.

2.4 Front buttons and led indicators

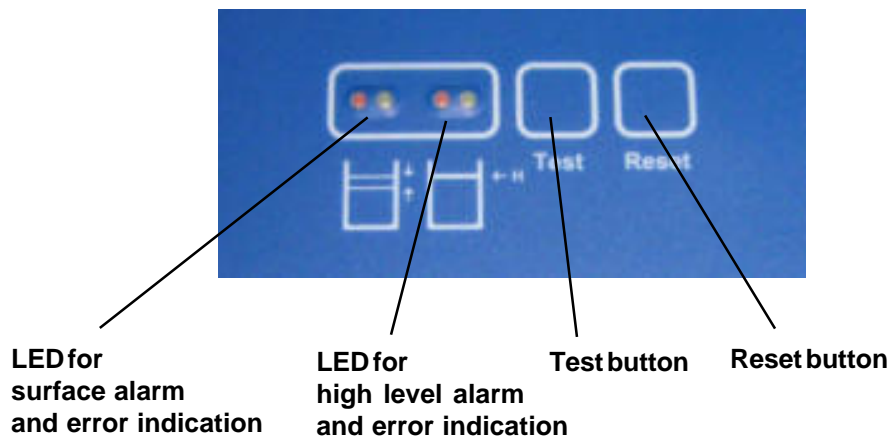

2.5 Technical Data

2.5.1 ema Signal OSA Alarm Unit specification:

Intrinsically safe	⊕ II (1) G [EEx ia] II B
Sensor output galvanically isolated from earth.	
Intrinsically safe parameters sensor output	C_0 : 0,60 μ F, L_0 : 2,0 mH I_0 : 170 mA, U_0 : 24,9 V P_0 : 1,1 W
Power Supply	230 V, 50 Hz
Relay outputs, contact data	U_m 250 V, I_m 5A, max 100 VA (AC) U_m 24 V, I_m 1,5A, 20 W (DC)
Ambient temperature electronic unit	± 0 to $+40^\circ\text{C}$
Protection	IP 65

2.5.2 Sensor specifications:

Capacitance probe type ES4

Intrinsically safe	⊕ II 1 G EEx ia II A T4
Sensor must be connected to barrier isolated from earth.	
Electrical parameters	C_i : 500 nF, L_i : 10 μ H I_i : 170 mA, U_i : 25,0 V P_i : 1,1 W
Ambient temperature sensor	-20 - $+40^\circ\text{C}$

Thermistor probe type R6

Intrinsically safe	⊕ II 1 G EEx ia II A T3
Sensor must be connected to barrier isolated from earth.	
Electrical parameters	C_i : 1 nF, L_i : 10 μ H I_i : 200 mA, U_i : 30,0 V P_i : 1,0 W
Ambient temperature sensor	-25 - $+50^\circ\text{C}$

3 INSTALLATION EMA SIGNAL OSA

3.1 Common information

Installation is only permitted by authorised and competent personnel. The OSA unit is designed for wall mounting. The unit must not be mounted in an EX zone. All regulations and instructions for the installation and maintenance of EX certified equipment must be observed (EN60079-14, EN60079-17 CENELEC)

3.2 Mounting

The protection class is IP 65.
Use 4 screws to mount the unit directly on a wall.

3.3 Connections

The cable should be mechanically protected.

If sensor cables need to be extended, screened cable (2 x 1,5 mm²) should be used, Maximum length 200 m for each sensor.

The intrinsically safe circuit is not allowed to be earthed.

Connections are made in accordance with the connection notation shown below. The power supply is connected to connector block K1. The capacitance sensor probe type ES4 is connected to block P1 and the thermistor sensor probe R6 (when used) is connected to block P2. The OSA unit has two voltage-free relay contacts, R1 is the output for the oil surface alarm provided by capacitance probe type ES4 and R2 is the output for the high level liquid alarm provided by thermistor probe type R6.

Cable connections for sensing probes and power supply:

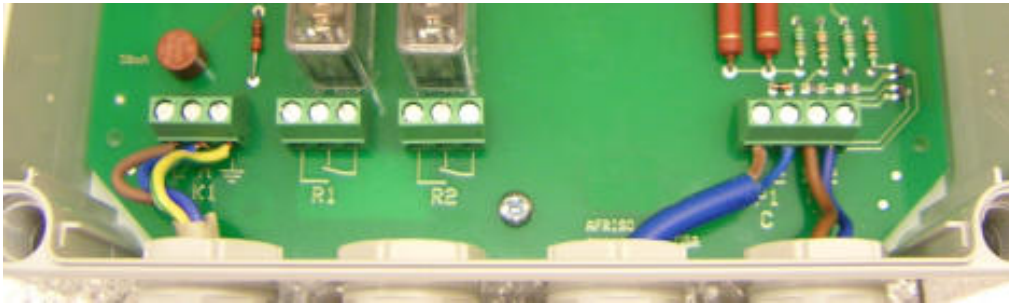

230V power supply

Cap. probe
1=Brown (1)
2=Blue (2)

Thermistor probe
1=Brown (1)
2=Blue (2)

3.4 Checking

Check the connections are made correctly in accordance with the connection details. Incorrect polarity of the sensor cables will result in an alarm on the OSA unit. Check the correct cable type and size has been used. Check the jumper link on the printed circuit board is in the correct position for the number of probes used. Setting 1 is for oil alarm only with a capacitance type ES4 sensor and setting 2 is used when the optional R6 thermistor sensor is also fitted for high level liquid alarm.



Make sure that foil connection is made correctly to the pin connector on the circuit board before the lid is closed.

3.5 Start Up

Connect the power supply to the OSA alarm unit. The unit will perform a diagnostic check of the sensor inputs. In the event of an incorrect connection or sensor fault an alarm will be given within 30 seconds.

3.6 Operating information

Normal	No sensor alarms given. Green LED's for "surface" and "high" will be illuminated. Relays R1 and R2 will be energized.
Oil Surface alarm	With an oil or grease surface alarm the red LED for "surface" will be illuminated and the internal buzzer sounds. Relay R1 will be de-energized.
High level alarm	When the liquid level in the separator reaches the R6 thermistor probe the red LED for "high" will be illuminated and the internal buzzer sounds. Relay R2 will be de-energized*.
Oil Sensor alarm	With a short circuit on the surface sensor input the red "surface" LED flashes at a rate of 1 Hz (quick flash), with an open circuit the flash rate is reduced to 1/3 Hz (slow flash). In either case the internal buzzer sounds and relay R1 will be de-energized*.
High level alarm	With a short circuit on the high level sensor input the red "high" LED flashes at a rate of 1 Hz (quick flash), with an open circuit the flash rate is reduced to 1/3 Hz (slow flash). In either case the internal buzzer sounds and relay R2 will be de-energized*.

(* = Fail safe operation)

Pressing the RESET pushbutton mutes the internal buzzer only, the operation of relay R1 and R2 is unaffected. The buzzer will sound again after approximately 20 hours if the alarm condition has not been corrected.

3.7 Warning!

The OSA unit will only give an alarm oil surface alarm if there is a definite oil or grease surface layer on the water in the separator chamber. Please be aware that certain solvents and chemicals can destroy or degrade the oil or surface layer which could make it impossible for the unit to provide a proper surface alarm.

The front cover of the OSA unit must not be removed when connected to a live power supply. Please isolate before removing the cover.

The OSA unit must never be installed within an EX zone. The sensor outputs are certified intrinsically safe and the ES4 and R6 sensors are suitable for mounting in an EX zone.

3.7 Repair and modification

Repair and modification is not permitted on site. The unit must be sent to the manufacturer or supplier for attention.



4 Installation capacitance probe type ES4 and thermistor probe type R6

4.1 General information

Installation is only permitted by authorised and competent personnel and all parts of the Installation Manual must be adhered to.

4.2 Mounting

The ES4 capacitance sensor should be fixed at a height 150 mm below the constant water level in the separator, and must be immersed in water to prevent an alarm being initiated.

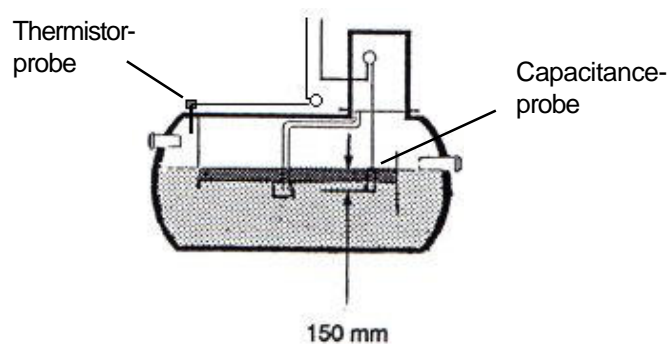

If a 1" cable gland is used for the mounting in the tank make sure that the cable is securely tightened. Make sure that the sensor is easy to lift out of the tank in order to protect the probe when emptying the tank.

The cable should be mechanically protected.

If the OSA unit is used for oil surface AND high level alarm functions, make sure the R6 thermistor probe is mounted at the correct level in the separator tank.

4.3 Checking

Ensure the sensors are mounted at the correct heights within the separator. (If in doubt this information should be obtained from the separator manufacturer or supplier, it is not the responsibility of the alarm system manufacturer).

Make sure that the cable glands are properly tightened.

Make sure that cables are connected according to the connection scheme and that the cable polarity is correct.

4.4 Connection for oil surface alarm only

OSA unit connected to ES4 capacitance sensor only.

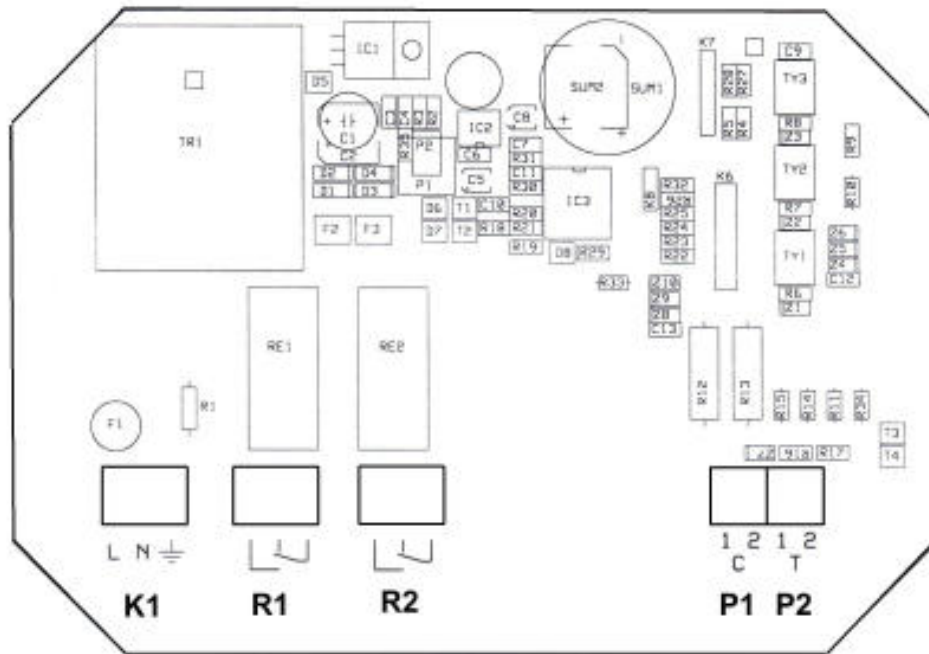

- K1 : Connection power supply 230 VAC**
- R1 : Voltage-free relay contact for oil surface alarm**
- P1 : Connection capacitance probe ES4**

R1 is shown de-energised. (With power supply off or in the alarm condition which gives Fail Safe operation.)

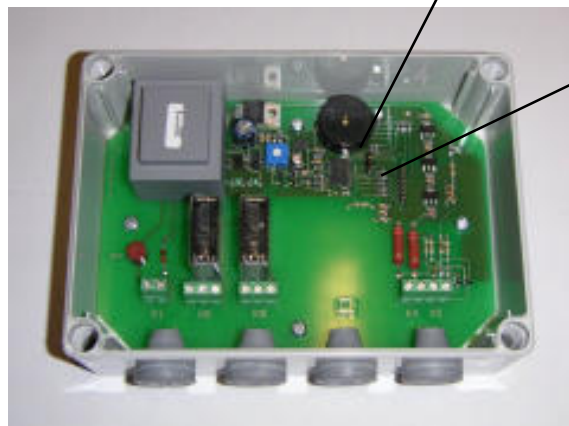
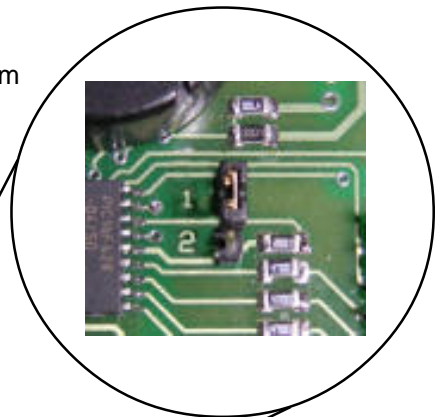

Jumper shown in pos 1 for oil surface alarm only. (factory default setting)

4.5 Connection for oil surface and high level liquid alarms

The unit is connected to capacitance probe ES 4 and thermistor probe R6.

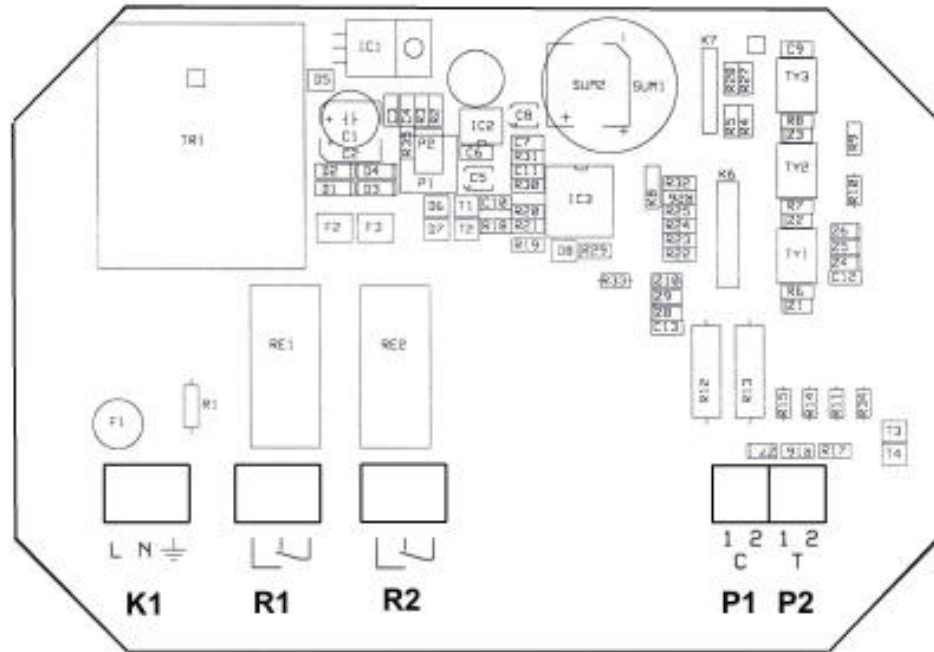

- K1** : Connection power supply 230 VAC
- R1** : Voltage-free relay contact for surface alarm
- R2** : Voltage-free relay contact for high level alarm
- P1** : Connection capacitance probe ES4
- P2** : Connection thermistor probe R6

R1 and R2 are shown in the de-energised state. (With power supply off or in an alarm condition, giving Fail Safe operation.)

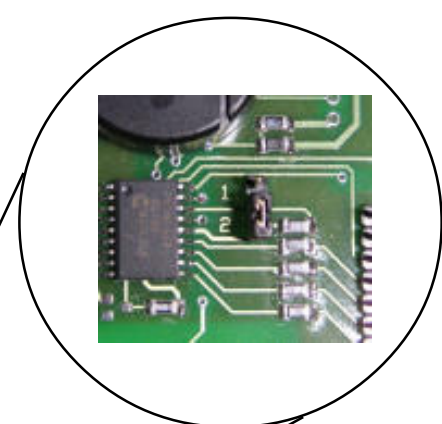

Jumper in pos 2 for both surface and high level alarm

5.1 Front buttons and LED indicators

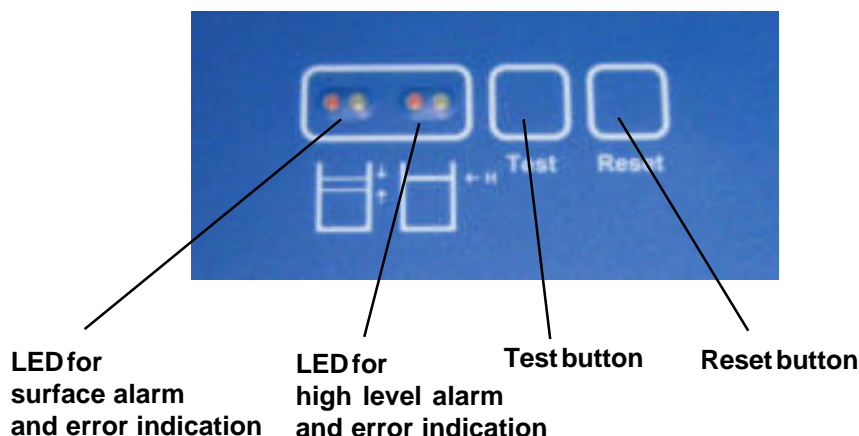

5.2 Start Up

Connect the power supply to the OSA unit. The unit will automatically perform a check of the sensor inputs and any alarms will be given within 30 seconds.

5.3 Operating Information

- Normal** No sensor alarms given. Green LED's for "surface" and "high" will be illuminated. Relays R1 and R2 will be energized.
- Oil Surface alarm** With an oil or grease surface alarm the red LED for "surface" will be illuminated and the internal buzzer sounds. Relay R1 will be de-energized.
- High level alarm** When the liquid level in the separator reaches the R6 thermistor probe the red LED for "high" will be illuminated and the internal buzzer sounds. Relay R2 will be de-energized*.
- Oil Sensor alarm** With a short circuit on the surface sensor input the red "surface" LED flashes at a rate of 1 Hz (quick flash), with an open circuit the flash rate is reduced to 1/3 Hz (slow flash). In either case the internal buzzer sounds and relay R1 will be de-energized*.
- High level alarm** With a short circuit on the high level sensor input the red "high" LED flashes at a rate of 1 Hz (quick flash), with an open circuit the flash rate is reduced to 1/3 Hz (slow flash). In either case the internal buzzer sounds and relay R2 will be de-energized*.

(* = Fail safe operation)

Pressing the RESET pushbutton mutes the internal buzzer only, the operation of relay R1 and R2 is unaffected. The buzzer will sound again after approximately 20 hours if the alarm condition has not been corrected.

5.4 Test function

The OSA unit has a built-in test function which as follows is used to test the alarm functions, the relay outputs and the LED indicators. The test is carried out as follows:

- Press the "TEST" pushbutton and hold for approximately 3 seconds. The following sequence will commence and the TEST pushbutton can be released -

For 5 seconds the "surface alarm" will be given. The red "surface" LED will be illuminated and relay R1 will be de-energised.

For the next 5 seconds the "high level" alarm will be given. The red "high" LED will be illuminated and relay R2 will be de-energised.

NOTE: The internal buzzer will sound continuously during the 10 seconds of the test sequence.

For the next 5 seconds no alarms will be given, the green LED's will be illuminated and relays R1 and R2 will be energised. After this sequence the unit will revert automatically to the normal operating condition.

6 CERTIFICATE

6.1 Certificate EMA SIGNAL OSA



CERTIFIKAT

Certificate issued by a Notified Body

SP 04ATEX3620X
(17 06 16)



1(2)

- [1] **EC-TYPE EXAMINATION CERTIFICATE**
- [2] **Equipment or Protective System intended for use in Potentially Explosive Atmospheres
Directive 94/9/EC**
- [3] EC-Type Examination Certificate Number: **SP 04ATEX3620X**
- [4] Equipment or Protective System: Separator Alarm type ema signal OSA
- [5] Applicant (manufacturer): AFRISO EMA AB
- [6] Address: Singelgatan 2, SE-212 28 Malmö, Sweden
- [7] This equipment or protective system and any acceptable variation thereto is specified in the schedule to this certificate and the documents therein referred to.
- [8] SP, Notified Body No. 0402 in accordance with Article 9 of the Council Directive 94/9/EC of 23 March 1994, certifies that this equipment or protective system has been found to comply with the Essential Health and Safety Requirements relating to the design and construction of equipment and protective systems intended for use in potentially explosive atmospheres, given in Annex II to the Directive.
- The examination and test results are recorded in a confidential report No. P303526:A
- [9] Compliance with the Essential Health and Safety Requirements has been assured by compliance with:
- EN 50014:1997 + A1...A2 (SS-EN 50014 ed 4 + A1...A2)
 - EN 50020:2002 (SS-EN 50020 ed 5)
 - EN 50284:1999 (SS-EN 50284 ed. 1)
- [10] If the sign "X" is placed after the certificate number, it indicates that the equipment or protective system is subject to special conditions for safe use specified in the schedule to this certificate.
- [11] This EC Type examination certificate relates only to the design, examination and tests of the specified equipment or protective system in accordance to the Directive 94/9/EC. Further requirements of the Directive apply to the manufacturing process and supply of this equipment or protective system. These are not covered by this certificate.
- [12] The marking of the equipment or protective system shall include the following

 **II (1) G [EEEx ia] IIB**

Borås 14 June 2004

**SP Swedish National Testing and Research Institute
Certification**

Lena Månsson
Certification manager

Åke Månsson
Certification officer

6.2 Certificate ES4



CERTIFICATE

Certificate issued by a Notified Body

SP 03ATEX3609X
(17 06 14)



- [1] **EC-TYPE EXAMINATION CERTIFICATE**
- [2] **Equipment or Protective System intended for use in Potentially Explosive Atmospheres
Directive 94/9/EC**
- [3] EC-Type Examination Certificate Number: **SP 03ATEX3609X**
- [4] Equipment or Protective System: Detector type ES4
- [5] Applicant (manufacturer): AFRISO EMA AB, Malmö, Sweden
- [6] Address: Singelgatan 2, SE-212 28 Malmö, Sverige
- [7] This equipment or protective system and any acceptable variation thereto is specified in the schedule to this certificate and the documents therein referred to.
- [8] SP, Notified Body No. 0402 in accordance with Article 9 of the Council Directive 94/9/EC of 23 March 1994, certifies that this equipment or protective system has been found to comply with the Essential Health and Safety Requirements relating to the design and construction of equipment and protective systems intended for use in potentially explosive atmospheres, given in Annex II to the Directive.
- The examination and test results are recorded in a confidential report No. P300337:B.
- [9] Compliance with the Essential Health and Safety Requirements has been assured by compliance with:
- EN 50014:1997 + A1...A2 (SS-EN 50014 ed. 4 + A1...A2)
 - EN 50020:2002 (SS-EN 50020 ed. 5)
 - EN 50284:1999 (SS-EN 50284 ed. 1)
- [10] If the sign "X" is placed after the certificate number, it indicates that the equipment or protective system is subject to special conditions for safe use specified in the schedule to this certificate.
- [11] This EC Type examination certificate relates only to the design, examination and tests of the specified equipment or protective system in accordance to the Directive 94/9/EC. Further requirements of the Directive apply to the manufacturing process and supply of this equipment or protective system. These are not covered by this certificate.
- [12] The marking of the equipment or protective system shall include the following

 **H 1 G EEx ia IIA T4**

Borås 4 July 2003

**SP Swedish National Testing and Research Institute
Certification**

Lenmar Månsson
Certification manager

Åke Månsson
Certification officer

6.3 Certifikat R6



CERTIFICATE

Certificate issued by a Notified Body

SP 03ATEX3604X
(17 06 08)



- [1] **EC-TYPE EXAMINATION CERTIFICATE**
- [2] **Equipment or Protective System intended for use in Potentially Explosive Atmospheres
Directive 94/9/EC**
- [3] EC-Type Examination Certificate Number: **SP 03ATEX3604X**
- [4] Equipment or Protective System: Thermistor level-sensor, type R6
- [5] Applicant (manufacturer): AFRISO EMA AB, Malmö, Sweden
- [6] Address: Singelgatan 2, SE-212 28 Malmö, Sverige
- [7] This equipment or protective system and any acceptable variation thereto is specified in the schedule to this certificate and the documents therein referred to.
- [8] SP, Notified Body No. 0402 in accordance with Article 9 of the Council Directive 94/9/EC of 23 March 1994, certifies that this equipment or protective system has been found to comply with the Essential Health and Safety Requirements relating to the design and construction of equipment and protective systems intended for use in potentially explosive atmospheres, given in Annex II to the Directive.
- The examination and test results are recorded in a confidential report No. P300337:A
- [9] Compliance with the Essential Health and Safety Requirements has been assured by compliance with:
- EN 50014:1997 + A1...A2 (SS-EN 50014 ed. 4 + A1...A2)
 - EN 50020:2002 (SS-EN 50020 ed. 5)
 - EN 50284:1999 (SS-EN 50284 ed. 1)
- [10] If the sign "X" is placed after the certificate number, it indicates that the equipment or protective system is subject to special conditions for safe use specified in the schedule to this certificate.
- [11] This EC Type examination certificate relates only to the design, examination and tests of the specified equipment or protective system in accordance to the Directive 94/9/EC. Further requirements of the Directive apply to the manufacturing process and supply of this equipment or protective system. These are not covered by this certificate.
- [12] The marking of the equipment or protective system shall include the following

 II 1 G EEx ia IIB T3

Borås 4 July 2003

**SP Swedish National Testing and Research Institute
Certification**

Lennart Månsson
Certification manager

Åke Månsson
Certification officer